

Raychem TANK HEATING



This step-by-step design guide provides the tools necessary to design a tank heating system for temperature maintenance using electric heating cables or tank heating pads. For design assistance, contact your Pentair Industrial Heat Tracing Solutions representative or phone Pentair at (800) 545-6258. Also, visit our web site at www.pentairthermal.com.

Contents

Introduction	92
Self-Regulating Heating Cables	93
Power-Limiting Heating Cables	93
Mineral Insulated Heating Cables	94
Tank Heating Pads	95
Tank Tracing Design and Product Selection	96
Overview	96
Tank Heat Loss Calculation	110

INTRODUCTION

Pentair provides a wide selection of heat-tracing solutions for tanks and vessels. Typical applications for electrical heat tracing of tanks and vessels include:

- Freeze protection of low and medium viscosity fluids (e.g., water, ammonia)
- Temperature maintenance for medium viscosity fluids (e.g., oils, resins)
- Crystallization prevention (e.g., caustic soda)
- Condensation prevention (e.g., fly ash in conical bases of silos)

Contact Pentair for heat-up applications, hazardous locations, heat tracing of high viscosity fluids (e.g. heavy oils), applications where agitation is used, and other nonstandard applications.

Tank heating applications can be quite varied. For this reason, Pentair offers a wide range of technologies to optimize your tank and vessel heat-tracing system.

- Self-regulating heating cables
- Power-limiting heating cables
- Tank heating pads
- Mineral insulated heating cables

A description of the features and benefits of each technology is provided, followed by the design and product selection steps.

TANK HEATING

Self-Regulating Heating Cables

Raychem brand self-regulating heating cables (BTV, QTVR, XTV, and KTV) are ideal for tank heating when design and installation flexibility are required. The benefits include:

Forgiving technology For over 40 years, Raychem self-regulating heating cables have proven their reliability and remain the premier self-regulating heating cables in the market.

Easy installation Because of parallel circuitry and flat cable design, Raychem self-regulating heating cables are easy to handle and install. They can be cut to any length on site and overlapped without the risk of overheating. Raychem cables readily accommodate design adjustments between specifications and actual on-site installation needs.

Uniform temperatures Heat is evenly distributed over the heat-traced surface. The self-regulating feature of the heating cable responds to actual conditions of the traced surface. Temperature control is simplified, especially for tanks with fill-height variation.

T-ratings Raychem self-regulating heating cables have a T-rating per national electrical codes.

Approvals Pentair self-regulating systems are approved and certified for use in nonhazardous and hazardous locations by many agencies, including FM, CSA, UL, PTB, Baseefa, NEPSI, DNV, ABS and many more.

Raychem self-regulating heating cables can be used to maintain temperatures up to 300°F (150°C). Technical information is provided in the data sheets on the Pentair web site, www.pentairthermal.com.

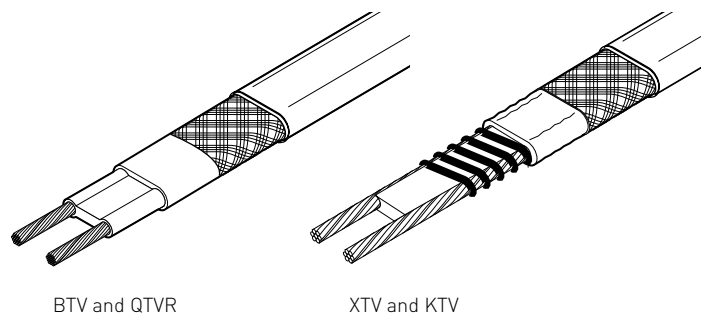

Fig. 1 Self-regulating heating cables

Power-Limiting Heating Cables

Raychem brand power-limiting heating cables (VPL) feature high power output at high maintain temperatures. These flexible heating cables are rated for maintain temperatures up to 455°F (235°C) and exposure temperatures (power off) to 500°F (260°C). Power-limiting heating cables feature:

Superior temperature capability in a flexible heater These cables are especially suited to applications requiring high power output at elevated temperatures and requiring field installation flexibility to accommodate small tank structure or design modifications.

Easy installation Cables can be cut to length and terminated in the field.

Uniform distribution of heat Heat is evenly and widely distributed over the heat-traced surface.

Approvals Pentair power-limiting systems are approved and certified for use in nonhazardous and hazardous locations by many agencies, including FM, CSA, UL, PTB, Baseefa, NEPSI, DNV, ABS and many more.

Additional technical information can be found in the data sheet. Data sheets can be found on the Pentair web site, www.pentairthermal.com, or the Technical data sheet section of the Industrial Heat Tracing Solutions Products & Services Catalogue (H56550).

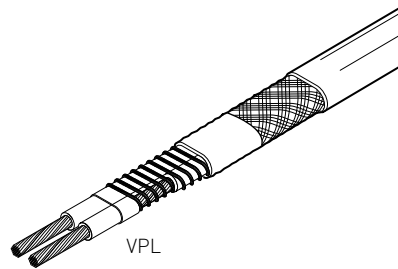

Fig. 2 Power-limiting heating cables

Mineral Insulated Heating Cables

Raychem brand mineral insulated heating cables (MI) offer a very reliable solution and are recommended for maintain temperatures above 300°F (150°C) or where exposure temperatures exceed 500°F (260°C). Raychem MI heating cables feature:

Superior toughness Raychem MI heating cables and nonheating cold leads are manufactured with a seamless sheath of Alloy 825 and have proven their reliability in over 40 years of service. MI provides superior toughness in dynamic cut-through and tough mechanical environments.

Easy installation Raychem MI heating cables are preterminated, eliminating the need for special termination expertise. Special annealing procedures maximize flexibility for ease of on-site handling.

Uniform temperatures Heat is evenly distributed over the heat-traced surface. Raychem MI heating cable on tank installations is the choice where both higher power and even distribution are required.

Approvals Pentair mineral insulated heating systems meet the requirements of the U.S. National Electrical Code and the Canadian Electrical Code.

Pentair MI systems are approved for use in hazardous locations. Based on the application, temperature ID number (T-rating) can be established by calculating the maximum sheath temperature. Contact Pentair for assistance.

Additional technical information can be found in the Mineral Insulated Heating Cables design guide (H56884) and on the data sheet. Data sheets can be found on the Pentair web site, www.pentairthermal.com, or the Technical data sheet section of the Industrial Heat Tracing Solutions Products & Services Catalogue (H56550).

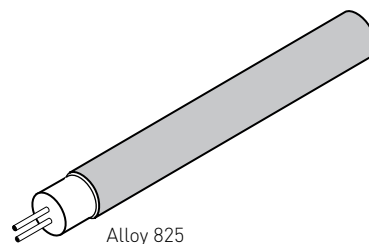

Fig. 3 MI heating cables

TANK HEATING

Tank Heating Pads

Raychem brand tank heating pads (RHS) are recommended when high wattage density is required. The RHS system provides heat to selected areas on the tank. The heat is then distributed through convection in the fluid (natural or agitated). RHS is built from durable components for use on tanks in industrial applications. The heating pads have a constant power output and are available with two power densities, making them suitable for both metal (lined and unlined) and plastic tanks. RHS tank heating pads have been designed to include the following benefits:

Easy installation Raychem RHS tank heating pads can easily be installed by a single person.

Over-temperature thermostat A sealed, self-resetting, over-temperature thermostat is integrated into the product.

Approvals FM Approvals (FM) and CSA Group (CSA) have approved RHS tank heating pads for both nonhazardous and hazardous locations.

Additional technical information can be found in the RHS data sheet (H56842).

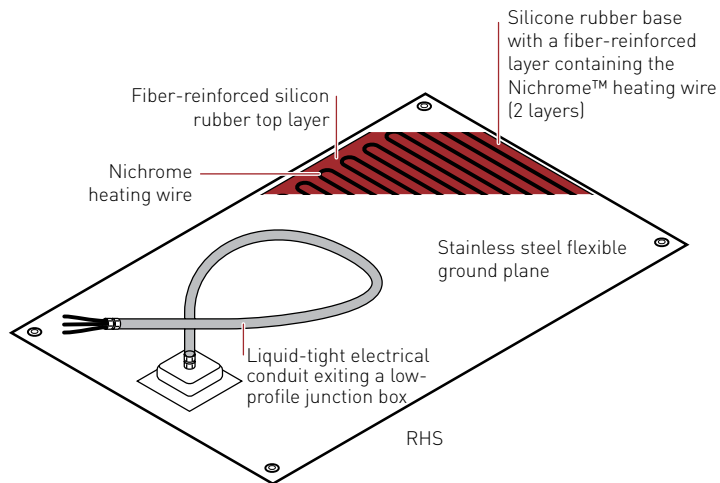

Fig. 4 Tank heating pads

The stainless steel grounding plane is flexible enough to contour to most tank surfaces, and it is oversized to protect the heating elements and maximize contact with the tank.

RHS can be used for maintain temperatures up to 200°F (93°C) and maximum exposure temperatures of 366°F (186°C). For technical details, refer to the RHS data sheet. Data sheets can be found on the Pentair web site, www.pentairthermal.com, or the Technical data sheet section of the Industrial Heat Tracing Solutions Products & Services Catalogue (H56550).

TANK TRACING DESIGN AND PRODUCT SELECTION

Overview

Follow the five steps below to select the heating products and create a bill of materials for your tank application. If your tank application requires heat-up or condensation prevention, contact Pentair for assistance.

- 1** Gather the necessary application data.
 - Tank type
 - Tank diameter
 - Tank height
 - Tank support
 - Tank insulation type and thickness
 - Maintain temperature
 - Tank contents
- 2** Calculate the tank heat loss.
- 3** Choose the heating technology.
- 4** Product selection.
- 5** Select the thermostatic control.

Tank Tracing
1. Gather information
2. Calculate tank heat loss
3. Choose heating technology
4. Product selection
5. Select thermostatic control

Step 1 Gather the necessary data

Gather and record the following information. Alternatively, use the design worksheet in Appendix B to record your application data. You will use this information for the steps that follow.

- Tank type _____
- Tank diameter _____
- Tank height _____
- Tank support _____
- Tank insulation type and thickness _____
- Maintain temperature _____
- Tank contents _____

Example: Information on three sample applications

Tank type (all)	Vertical cylinder
Tank diameter (all)	3 ft
Tank height (all)	6 ft
Tank support (all)	4 legs
Tank insulation type and thickness (all)	Fiberglass insulation, 2-in
Tank 1 Maintain temperature	100°F at 0°F
Contents	polyol
Tank 2 Maintain temperature	40°F at 0°F
Contents	water
Tank 3 Maintain temperature	400°F at 0°F
Contents	bitumen

Tank Tracing
1. Gather information
2. Calculate tank heat loss
3. Choose heating technology
4. Product selection
5. Select thermostatic control

Step 2 Calculate the tank heat loss

The tank’s thermal heat loss determines the power needed to maintain the tank at the desired temperature. To determine the heat loss, see “Tank Heat Loss Calculation” section, for formulas and tables. Using these resources, the heat loss of the example tanks was found to be:

Example: Results of tank heat loss calculations

Tank 1: $Q_{total} = 458 \text{ W}$ (from Tank Heat Loss calculation)

Tank 2: $Q_{total} = 178 \text{ W}$ (from Tank Heat Loss calculation)

Tank 3: $Q_{total} = 2070 \text{ W}$ (from Tank Heat Loss calculation)

Tank Tracing
1. Gather information
2. Calculate tank heat loss
3. Choose heating technology
4. Product selection
5. Select thermostatic control

Step 3 Choose the heating technology

Pentair offers a range of tank heating solutions.

Table 1 provides a rough guide for the selection of technologies for different applications. The continuing discussion that follows will help you understand and select the appropriate technology when more than one product choice is available or when an application does not easily fit those defined in the table.

Your choice of heating method depends on factors such as:

- Required maintain and exposure temperatures
- Material of the tank wall (metal or plastic)
- Temperature sensitivity and viscosity of the tank contents
- Whether or not the tank is agitated
- Additional requirements such as heat-up or prevention of condensation

TABLE 1 PRODUCT SELECTION GRID

Application or requirement	Self-regulating		Power-limiting VPL	Mineral insulated MI	Tank pads	
	BTV	QTVR, XTV, KTV			RHS-L	RHS-H
Flexible field design required	•	•	•			
Plastic tank wall	•	•			•	
Plastic-lined tank wall	•	•			•	
Even heat to all walls needed	•	•	•			
Maintain temperature more than 120°F (49°C)	•	•	•	•		•
Maintain temperature more than 200°F (93°C)		•	•	•		
Maintain temperature more than 300°F (150°C)			•	•		
Low installed cost desired					•	•
High watt density needed		•	•	•		•
Distributed high watt density needed			•	•		
Temperature-sensitive fluids	•	•				
Condensation prevention	•	•	•	•		
Small-diameter stagnant tanks	•	•				
Limited tank surface area available			•	•		•
High heat-loss tanks			•	•		•

SELF-REGULATING HEATING CABLES

Uses

- Tanks containing temperature-sensitive fluids
- Tank materials such as PVC or PE
- Applications requiring uniform heating (condensation prevention)
- Tanks with unusual shapes to trace

Advantages

- Very flexible design and installation
 - Cables can be installed on any type of tank surface
 - Cables adapt to any shape or surface
 - Cables allow tracing with more power on high heat loss areas — just reduce the spacing between the heating cables in those areas
 - Cables can be cut to length in the field
- Even heat distribution due to larger heated surface
- Very smooth heating for tank walls with a low withstand temperature

POWER-LIMITING HEATING CABLES

Uses

- Tanks containing fluids that are less temperature sensitive
- Tanks with high heat loss, and where flexibility in installation is a premium
- Tanks with a maintain temperature between 250°F (121°C) and 300°F (150°C)

Advantages

- Very flexible design and installation
 - Cables can be installed on any type of tank surface
 - Cables adapt to any shape or surface
 - Cables allow tracing with more power on high heat loss areas — just reduce the spacing between the heating cables in those areas
 - Cables can be cut to length in the field
- Even heat distribution due to larger heated surface
- Very smooth heating for tank walls with a low withstand temperature

MINERAL INSULATED HEATING CABLES

Uses

- Maintain temperatures above 300°F (150°C)
- Exposure temperatures above 500°F (260°C)
- Tanks with high heat loss or high power requirements at elevated temperatures

Advantages

- Flexible design and installation
 - Cables can be installed on any type of tank surface
 - Cables can adapt to any shape or surface
 - Cables allow tracing with more power on high heat-loss areas — just reduce the spacing between the heating cables in those areas
- Even heat distribution due to larger heated surface
- Capability for high power output and density

TANK HEATING PADS

Uses

- Tanks containing fluids that are not temperature sensitive
- Tanks where the surface is space-constrained
- Tanks with high heat loss
- Fluids with low viscosity (such as water or light oil)

Advantages

- Lower installation cost
- Capability for high power output and watt density

Tank Tracing
1. Gather information
2. Calculate tank heat loss
3. Choose heating technology
4. Product selection
5. Select thermostatic control

Step 4 Product selection

When you have determined the most appropriate heating technology for your application, proceed to:

Step 4a Product selection for self-regulating and power-limiting heating cables

Step 4b Product selection for mineral insulated heating cables

Step 4c Product selection for tank heating pads

Example:

Tank 1: We recommend the use of self-regulating heating cables.

Tank 2: We recommend the use of RHS tank heating pads.

Tank 3: We recommend the use of MI mineral insulated heating cables.

Step 4a Product selection for self-regulating and power-limiting heating cables

OVERVIEW

- Orientation of tank
- Spacing and arrangement of the heating cables
- Traced surface
 - Vertical cylindrical tanks
 - Horizontal cylindrical tanks
 - Conical outlets
- Thermal design for heating cables
 - Determine heating cable compatible with your tank application
 - Select heating cable with the lowest maximum exposure temperature
 - Adjust for aluminum tape attachment
 - Determine minimum required length of heating cable
 - Determine cable distribution
- Electrical design of heating cable
 - Determine maximum allowable circuit length of heating cable
 - Adjust for aluminum tape attachment
 - Ground-fault protection
- Heating cable component selection

The heating cable you select and the length of cable you will need depend on the orientation of the tank and the spacing and arrangement of the heating cables.

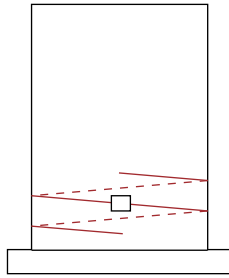

Fig. 5 Heating cable arrangement on a vertical tank

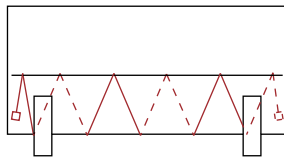

Fig. 6 Heating cable arrangement on a horizontal tank

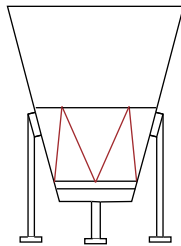

Fig. 7 Heating cable arrangement on a truncated cone

DETERMINATION OF THE TRACED SURFACE

Vertical cylindrical tanks

Vertical cylindrical tanks are traced on the lower one-third of the side wall (maximum half) and the bottom (if accessible).

Horizontal cylindrical tanks

Horizontal cylindrical tanks are traced on a third of the bottom (maximum half).

Conical outlets

Conical outlets of vessels are often traced to prevent condensation inside. We recommend that the entire surface of the conical outlet be traced and additional tracing is recommended on heat sinks, such as fixings/supports. Heat sinks should be thermally isolated. Because the surface area of the conical outlet is often much smaller than the rest of the vessel, it may be necessary to extend the tracing beyond the conical area in order to fully compensate for the heat loss.

THERMAL DESIGN USING HEATING CABLES

Determine the heating cable families compatible with your tank application

To select a heating cable that is compatible with your application, familiarize yourself with the selection process for pipes as outlined in Self-Regulating Cables design guide (H56882) and Power-Limiting Cables design guide (H56883). Considering factors such as exposure temperature, maintain temperature, wall material, hazardous location requirements, etc., list all heating cable families that would be compatible with your tank application — e.g., BTV, QTVR, XTV, KTV, VPL. The power outputs for the different heating cables are found in the Self-Regulating Cables and Power-Limiting Cables design guides.

Select the heating cable with the lowest maximum exposure temperature

Use the heating cable with the lowest possible maximum exposure temperature. Within each heating cable family, start with the cable that has the highest power output.

Example: Heating cable selection

Tank 1

Maintenance temperature 100°F maintain (from Step 1)
 Heat loss 458 W (from Step 2)
 Recommended cable Raychem 10BTV2-CR

Adjust for aluminum tape attachment

For optimal heat transfer, the heating cable must be fixed to the tank wall (both metal and plastic) with aluminum tape. For self-regulating cables on metal tanks, this leads to an increase in the power output; on plastic tanks, the much lower thermal conductivity of plastic requires a de-rating of the power output of the cables. Table 2 below provides approximate adjustment factors for the power.

TABLE 2 APPROXIMATE POWER OUTPUT CHANGE FOR HEATING CABLES ATTACHED WITH ALUMINUM TAPE AT-180

Heating cable	Adjustment factor on metal tanks	Adjustment factor on polypropylene tanks	Adjustment factor on fiber-reinforced plastic tanks
BTV	1.20	0.70	0.80
QTVR	1.20	N/R	N/R
XTV/KTV	1.15	N/R	N/R
VPL	1	N/R	N/R

N/R Not recommended due to temperature limitations of tank wall.

Multiply the power output at the maintain temperature (P_{heater}) by the appropriate adjustment factor f_{adj} from Table 2 above.

Formula: $P_{adj} = P_{heater} \times f_{adj}$

Example: Calculating the adjusted power of the heating cable (P_{adj})

Input $P_{heater} = 3.7$ W/ft (10BTV2-CR power output at 100°F)

Input $f_{adj} = 1.20$ (from Table 2)

Calculation $P_{adj} = 3.7$ W/ft \times 1.20

$P_{adj} = 4.4$ W/ft for Raychem 10BTV2-CR at 100°F

Divide the total heat loss (Q_{total}) by the adjusted power of the heating cable (P_{adj}) at the desired maintain temperature to obtain the minimum required length (L_{heater}).

$$\text{Formula } L_{heater} = \frac{Q_{total} \text{ (W)}}{P_{adj} \text{ (W/ft)}} \text{ (round up)}$$

Example: Calculating the minimum required cable length (L_{heater})

Input $Q_{total} = 458 \text{ W}$ (from Step 2)

Input $P_{adj} = 4.4 \text{ W/ft}$ (from previous calculation)

$$\text{Calculation } L_{heater} = \frac{458 \text{ W}}{4.4 \text{ W/ft}} \text{ (round up)}$$

$L_{heater} = 104 \text{ ft}$ (rounded up)

Next, determine how to distribute cable over the surface you wish to trace. An average spacing of the heating cable ($T_{average}$) can be calculated by dividing the traced surface (S_{traced}) by the total length of the heating cable (L_{heater}).

$$\text{Formula } T_{average} = \frac{S_{traced} \text{ (ft}^2\text{)}}{L_{heater} \text{ (ft)}} \text{ (round up)}$$

Example: Determining cable distribution

For our vertical cylinder tank (3 ft diameter, 6 ft high), tracing the lower one-third of the wall of the tank:

Input $S_{traced} = 3 \text{ ft} \times 3.14 \times 2 \text{ ft}$ (as determined in Step 4a)

Input $L_{heater} = 104 \text{ ft}$ (from previous calculation)

$$T_{average} \text{ (ft)} = \frac{(3 \text{ ft} \times 3.14 \times 2 \text{ ft})}{104 \text{ ft}} = \frac{(18.8 \text{ sq ft})}{104 \text{ ft}} = 0.18 \text{ ft (2.2 in)}$$

In this case, the result is close to the minimum spacing interval, so some of the tracing may be placed on the bottom of the tank. The spacing should be reduced locally to bring more power to areas that require more heat, such as supports and fixings. The maximum spacing should typically not be more than 12 inches (~300 mm). Do not space adjacent heating cable closer than two inches (50 mm), because interaction will occur and power output will decrease.

By changing the heating cable and the spacing in the calculation, you can obtain the solution that best fits the specific requirements of your tank application.

ELECTRICAL DESIGN OF HEATING CABLE

Determine maximum allowable circuit length

To determine the maximum allowable circuit length of your heating cable, refer to the data sheet on the Pentair web site for that heating cable. For metal tanks, however, the maximum circuit length needs to be reduced by the appropriate factor shown in Table 3 because of the use of the aluminum tape and the increased power. For plastic tanks, the maximum circuit length need not be adjusted.

Adjust for aluminum tape

TABLE 3 APPROXIMATE ADJUSTMENT FACTORS FOR MAXIMUM CIRCUIT LENGTH OF SELF-REGULATING HEATING CABLES ON METAL SURFACES ATTACHED WITH AT-180 ALUMINUM TAPE

Heating cable	Circuit length adjustment factor on metal tanks
BTV	0.8
QTVR	0.8
XTV/KTV	0.83

⚠ WARNING: Fire hazard
 There is a danger of fire from sustained electrical arcing if the heating cable is damaged or improperly installed. To comply with Pentair requirements, certifications, and national electrical codes, and to protect against the risk of fire, ground-fault equipment protection must be used on each heating cable circuit. Arcing may not be stopped by conventional circuit breakers.

TANK HEATING

Simply multiply the allowed footage shown on the heating cable data sheet on the Pentair web site by this factor to determine the footage that can be installed on a given breaker size.

Ground-fault protection

To minimize the danger of fire from sustained electrical arcing if the heating cable is damaged or improperly installed, and to comply with the requirements of Pentair, agency certifications, and national electrical codes, ground-fault equipment protection must be used on each heating cable branch circuit. Arcing may not be stopped by conventional circuit protection. Many Raychem control and monitoring systems meet the ground-fault protection requirement.

CONNECTION KIT SELECTION FOR SELF-REGULATING AND POWER-LIMITING CABLES

Now that you have determined your heating cable type and length, use the following chart to select the proper connection kits.

Note: Pentair offers a full range of connection kits for power connections, splices, and end seals. These connection kits must be used to ensure proper functioning of the product and compliance with warranty, code, and approvals requirements.

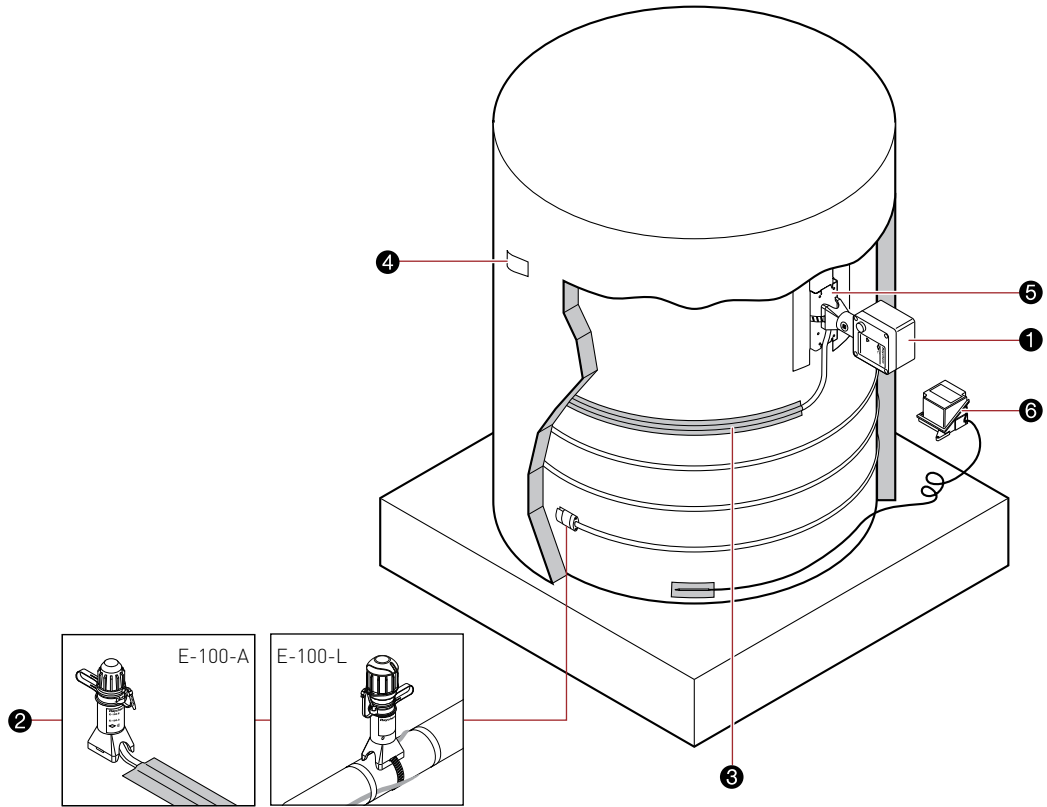

Fig. 8 Tank-tracing system connection kits and accessories

⚠ WARNING: Fire hazard

To prevent fire or shock, Raychem brand specified connection kits must be used. Do not substitute parts or use vinyl electrical tape.

TABLE 4 CONNECTION KIT AND ACCESSORY SELECTION FOR SELF-REGULATING AND POWER-LIMITING CABLES

Description	Catalog number
Connection kits	
❶ Power connection kit (not shown)	JBS-100-A
Power connection kit with light	JBS-100-L-A
Splice connection (not shown)	S-150 (not for use with VPL)
End seal	
Below insulation	E-150 (not for use with VPL)
Above insulation	E-100-A
Above insulation, with light	E-100-L-A (100-277 V)
Accessories	
❸ Aluminum tape	AT-180
❹ Labels	ETL
❺ Support bracket	SB-100-T
Controls	
❻ Thermostat (see Control and Monitoring design guide (H56889))	

Tank Tracing
1. Gather information
2. Calculate tank heat loss
3. Choose heating technology
4. Product selection
5. Select thermostatic control

Step 4b Product selection for mineral insulated heating cables

For MI product selection and design, refer to Mineral Insulated Heating Cables design guide (H56884) or contact your Pentair representative.

Step 4c Product selection for tank heating pads

Tank material and power density determine which RHS tank heater series to select. The number of heaters required depends on the amount of heat distribution the application requires. A large number of low-power pads will disperse the heat better than a few high-power heaters. Pentair recommends distributing the heat over as much wall surface as is economically feasible.

Note: Pentair does not recommend the use of tank heating pads for applications with:

- Highly temperature-sensitive fluids
- High-viscosity fluids
- Double-wall tanks
- Tank diameters of less than four feet
- A requirement for uniform heating
- A location where an installation temperature above 0°F (-18°C) cannot be assured.

TANK MATERIAL

Table 1 on page 6, indicates the heater to select based on tank type, heat loss, and surface area available.

Metal tanks

RHS-H series heaters are used for metal tanks. RHS-H heaters have a power density of 1.9 W/in² at the specified voltage with integrated thermostatic over-temperature protection.

Table 5 lists the RHS-H configurations available. To determine the number of heaters required, divide the final design heat loss for the tank by the heater’s power output.

TABLE 5 RHS-H SPECIFICATIONS (NOMINAL)

Catalog number	Overall dimensions	Voltage (Vac)	Power output (W)	Current draw (A)
RHS-H-500-1	14" x 24" (356 mm x 610 mm)	120	500	4.2
RHS-H-1000-1	24" x 26" (610 mm x 660 mm)	120	1000	8.3
RHS-H-1400-1	24" x 36" (610 mm x 914 mm)	120	1400	11.7
RHS-H-500-2	14" x 24" (356 mm x 610 mm)	240	500	2.1
RHS-H-1000-2	24" x 26" (610 mm x 660 mm)	240	1000	4.2
RHS-H-1400-2	24" x 36" (610 mm x 914 mm)	240	1400	5.8

Polypropylene, FRP, and metal tanks

RHS-L series heaters are for plastic or metal tanks. RHS-L heaters have a power density of 0.6 W/in² at the specified voltage with integrated thermostatic over-temperature protection. The available RHS-L configurations are shown in Table 6.

TABLE 6 RHS-L SPECIFICATIONS (NOMINAL)

Catalog number	Overall dimensions	Voltage (Vac)	Power output (W)	Current draw (A)
RHS-L-150-1	14" x 24" (356 mm x 610 mm)	120	150	1.3
RHS-L-300-1	24" x 26" (610 mm x 660 mm)	120	300	2.5
RHS-L-420-1	24" x 36" (610 mm x 914 mm)	120	420	3.5
RHS-L-150-2	14" x 24" (356 mm x 610 mm)	240	150	0.6
RHS-L-300-2	24" x 26" (610 mm x 660 mm)	240	300	1.3
RHS-L-420-2	24" x 36" (610 mm x 914 mm)	240	420	1.8

Considerations for plastic tanks

When designing heating systems for plastic tanks, be sure to keep the wall temperature below the recommended maximum material temperature. Common plastic tank walls are polyethylene and FRP. This section provides the algorithms you may use to determine the temperature generated by RHS tank heating pads.

Determine the power density of the RHS-L heater, Q_A .

- $Q_A = 295 \text{ Btu/ft}^2\text{-hr}$ equal to 0.6 W/in^2 for nominal voltages of 120 Vac and 240 Vac
- For voltages other than 120 Vac and 240 Vac,
 $(Q_A)_{\text{adjusted}} = (Q_A) \times (V/V_{\text{nominal}})^2$

Determine the maximum fluid maintain temperature, T_f . Enter this data on the design worksheet found in Appendix B.

Determine the fluid gradient, ΔT_f . The fluid gradient will depend on fluid type and temperature. For applications not involving temperature-sensitive fluids, the following values may be used for simplicity.

- $\Delta T_f = 10^\circ\text{F}$ (6K) for fluids similar to water
- $\Delta T_f = 30^\circ\text{F}$ (16K) for fluids similar to warm light oils
- $\Delta T_f = 100^\circ\text{F}$ (56K) for fluids similar to warm heavy oils

Calculate the tank wall gradient, ΔT_w . The gradient depends on wall thickness, t (inches), and material conductivity, k .

$$\Delta T_w = Q_A \times t/k$$

Wall thickness is expressed in inches. Typical conductivity values for high-temperature plastics are:

- $k = 1.7 \text{ Btu-in/hr-ft}^2\text{-}^\circ\text{F}$ for polypropylene (PE)
- $k = 2.1 \text{ Btu-in/hr-ft}^2\text{-}^\circ\text{F}$ for fiber-reinforced plastic (FRP)

Calculate the maximum outer wall temperature, $T_{\text{out-max}}$

$$T_{\text{out-max}} = T_f + \Delta T_f + \Delta T_w$$

Contact the tank manufacturer to determine the type and temperature capability of the tank material. The maximum temperature for polypropylene and FRP is typically 220°F (104°C). Other plastics, like PVC and polyethylene, have much lower temperature capabilities and are more suitable for use with Raychem self-regulating heating cables.

Example:

Tank Checklist

Fluid:	Water	Maintain temperature:	50°F
Tank material:	FRP	Tank wall thickness:	1/2-in
RHS heater:	RHS-L-XXX	Voltage:	277 Vac

Calculate adjusted heater power density:

$$(Q_A)_{\text{adjusted}} = (295) \times (277/240)^2 = 393 \text{ Btu/ft}^2\text{-hr}$$

Determine fluid maintain temperature: $T_f = 50^\circ\text{F}$

Determine fluid gradient for water: $\Delta T_f = 10^\circ\text{F}$

Calculate wall gradient for a FRP tank with 1/2" wall thickness:

$$\Delta T_w = (393 \times 0.5) / 2.1 = 94^\circ\text{F}$$

Calculate maximum outer wall temperature:

$$T_{\text{out-max}} = 50^\circ\text{F} + 10^\circ\text{F} + 94^\circ\text{F} = 154^\circ\text{F}$$

The maximum material temperature for FRP is approximately 220°F. Therefore, the application is compatible with the tank material.

Power adjustment factors

For all heating pads with catalog number X-XXX2, power output is calculated at 240 Vac. If the source voltage is either 208 Vac or 277 Vac, the following power output adjustment factors should be used.

208 Vac: Power output adjustment factor = 0.75

277 Vac: Power output adjustment factor = 1.33

Location and arrangement of heating pads

For vertical tanks, locate the heater on the lower one-third of the tank wall. Arrange the heaters on vertical, horizontal, and truncated cone tanks as shown in Fig. 1 through Fig. 1.

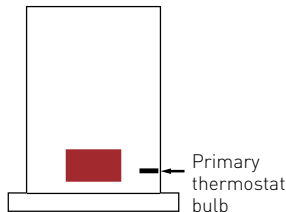

Fig. 9 Vertical tanks with RHS heaters

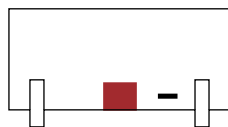

Fig. 10 Horizontal tanks with RHS heaters

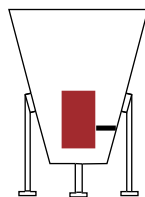

Fig. 11 Truncated cones with RHS heaters

⚠ WARNING: Fire hazard

There is a danger of fire from sustained electrical arcing if the heating cable is damaged or improperly installed. To comply with Pentair requirements, certifications, and national electrical codes, and to protect against the risk of fire, ground-fault equipment protection must be used on each heating cable circuit. Arcing may not be stopped by conventional circuit breakers.

Tank heating pad — electrical design

Size your circuit breaker according to the load of the heating pad(s). If your tank requires several heating pads, these can be grouped to one electrical circuit as long as the circuit breaker rating allows.

Ground-fault protection

To minimize the danger of fire from sustained electrical arcing if the heating pad is damaged or improperly installed, and to comply with the requirements of Pentair, agency certifications, and national electrical codes, ground-fault equipment protection must be used on each heating pad branch circuit. Arcing may not be stopped by conventional circuit protection. Many Raychem control and monitoring systems meet the ground-fault protection requirement.

Heating pad — accessory selection

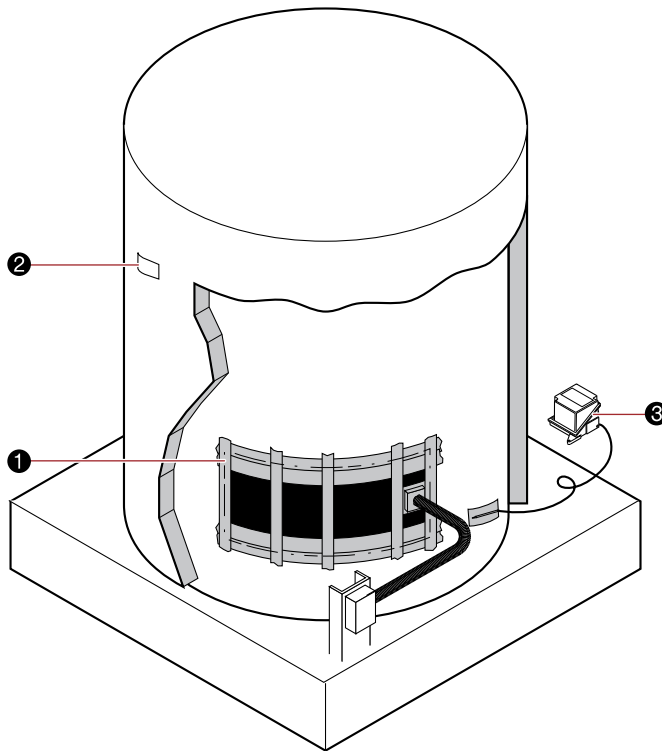

Fig. 12 Tank pad system components

⚠ WARNING: Fire hazard

To prevent fire or shock, Raychem brand specified components must be used. Do not substitute parts or use vinyl electrical tape.

TABLE 7 ACCESSORY SELECTION FOR TANK PAD HEATERS

Description	Catalog number
Components	
① Installation kit	RHS-INSTALLATION-KIT
② Labels	ETL
③ Thermostat (see Control and Monitoring design guide [H56889])	

Tank Tracing
1. Gather information
2. Calculate tank heat loss
3. Choose heating technology
4. Product selection
5. Select thermostatic control

Step 5 Select the thermostatic control

There are two kinds of sensors for indicating temperature: “in-fluid” and “on-surface.”

The “in-fluid” approach typically uses a thermowell protruding through the tank wall and into the fluid. Control of the heater is achieved by using a solid-state control device that receives its input from an RTD inside the thermowell.

The “on-surface” approach uses RTDs or bulb and capillary thermostats to control tank heaters by sensing temperatures on the outside surface of the tank wall. Sensors should be located midway between heating cables or heating pads. If your application has high heat-loss supports or accessories, place the primary sensor midway between the heating pad or cable and the support or accessory. The primary temperature sensor should be placed horizontally on the tank, refer to Fig. 9, Fig. 10, Fig. 11, and Fig. 12.

Raychem RHS tank heaters have integrated, resettable thermostats that provide over-temperature protection in the event of a primary thermostat failure. The RHS integrated thermostat **must not** be used as the primary means of temperature control.

For more details regarding the many options in control devices see Control and Monitoring design guide (H56889).

TANK HEAT LOSS CALCULATION

The Tank Tracing Design and Product Selection section presented a general approach to selecting a heat-tracing system for a tank or vessel. The tank heat loss can be calculated by using the graphs and equations on the following pages. The approach for the calculation is based on those in the TraceCalc Pro design software.

The overall heat loss (Q_T) of an insulated tank can be expressed as:

$$Q_T = Q_V + Q_S + Q_A$$

where:

Q_V = Heat loss through the insulated body of the tank

Q_S = Heat loss through the tank support mechanism (slab, legs, saddle, or other base support)

Q_A = Heat loss through accessories such as manholes, handholds, ladders, or handrails

To calculate the tank's overall heat loss (Q_T), follow these six steps:

- 1** Calculate the surface area of the tank.
- 2** Calculate the Q_V (heat loss through the insulated body of the tank).
- 3** Calculate the Q_S (heat loss through the base support).
- 4** Calculate the Q_A (heat loss through the accessories).
- 5** Calculate the Q_T (overall heat loss).
- 6** Calculate the final-design heat loss.

The heat-loss rates for insulated tank bodies (see Table 9 and Graph 1) are based on the following IEEE 515 provisions:

- Fiberglass insulation
- Tank located outdoors
- No insulating airspace between the tank surface and insulation

The tank body heat loss rates in Table 9 and Graph 1 assume a tank that is completely full and insulated with a minimum of one inch of fiberglass. However, Table 10 provides factors for adjusting the tank body heat loss for insulations other than fiberglass.

Tank Heat Loss Calculation
1. Calculate surface area of tank
2. Calculate Q_v
3. Calculate Q_s
4. Calculate Q_A
5. Calculate Q_T
6. Calculate final-design heat loss

Step 1 Calculate the surface area of the tank

CYLINDER SURFACE AREA

The surface area of the cylindrical tank is equal to the area of the body (A_{body}) plus the area of both ends of the tank (A_{end}), or, in the case of a vertical cylinder resting on a slab, the area of the tank body (A_{body}) plus the area of the top (A_{end}). If the tank is a vertical cylinder resting on a slab, do not add in the bottom area at this point.

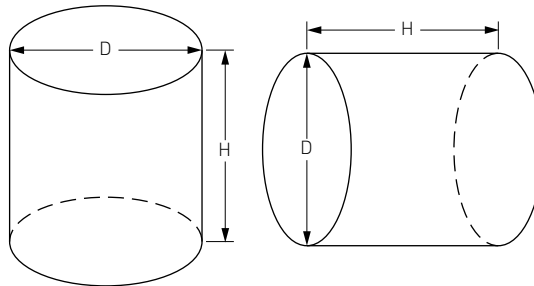

Fig. 13 Cylinder surface areas

To calculate the total surface area (A_v) of the tank cylinder:

- Calculate the surface area of the body:
 $(A_{body}) = \pi DH$
- Calculate the surface area of one or both ends:
 $(A_{end}) = \pi D^2/4$ or $(A_{end}) = (\pi D^2/4) \times 2$
- Add the results.

Table 8 below provides both the end and body areas of cylindrical tanks 6 to 20 feet in diameter and 8 to 25 feet high.

TABLE 8 CYLINDRICAL TANK SURFACE AREAS

D (ft)	A_{end} (ft ²)	A_{body} (ft ²)																	
		H (ft)																	
		8	9	10	11	12	13	14	15	16	17	18	19	20	21	22	23	24	25
6	29	151	170	189	208	227	245	264	283	302	321	340	359	311	396	415	434	453	471
7	39	176	198	220	242	264	286	308	330	352	374	396	418	440	462	484	506	528	550
8	51	202	227	252	277	302	327	352	377	403	427	452	478	503	528	553	579	604	629
9	64	227	255	283	311	340	368	396	425	453	481	509	538	566	594	622	650	679	707
10	79	252	283	315	346	377	409	440	472	503	535	565	597	629	660	692	723	754	786
11	95	277	311	346	381	415	450	484	519	553	588	622	657	692	726	761	795	830	864
12	114	302	340	377	415	453	491	528	566	604	641	679	717	754	792	830	868	905	943
13	133	327	368	409	450	491	531	572	613	654	695	736	776	817	858	899	940	981	1021
14	154	352	396	440	484	528	572	616	660	704	748	792	836	880	924	968	1012	1055	1100
15	177	377	425	472	519	566	613	660	707	754	802	849	896	943	990	1037	1084	1131	1179
16	202	403	453	503	553	604	654	704	754	805	855	905	955	1006	1056	1106	1157	1207	1257
17	227	427	481	535	588	641	695	748	802	855	908	962	1015	1069	1121	1175	1229	1282	1336
18	255	452	509	565	622	679	736	792	849	905	962	1018	1075	1131	1188	1244	1301	1357	1414
19	284	478	538	597	657	717	776	836	896	955	1015	1075	1135	1194	1254	1314	1373	1433	1493
20	315	503	566	629	692	754	817	880	943	1006	1069	1131	1194	1257	1320	1383	1446	1508	1571

Note: For the area of a horizontal tank, add the area of both ends.

TRUNCATED CONE SURFACE AREA

The total surface area (A_v) of a truncated cone tank (Fig. 14) is calculated as follows:

$$(A_v) = (A_{body}) + (A_{top}) + (A_{bottom})^*$$

* Do not include (A_{bottom}) if the bottom of the tank is resting on a slab.

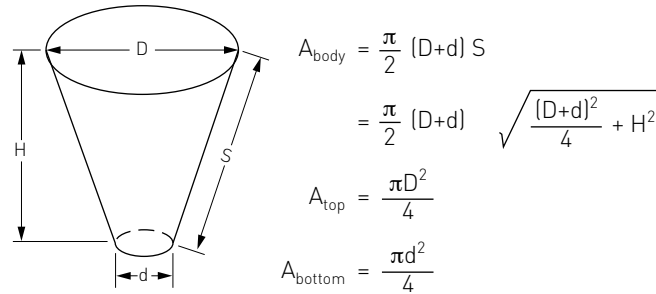

$$A_{body} = \frac{\pi}{2} (D+d) S$$

$$= \frac{\pi}{2} (D+d) \sqrt{\frac{(D+d)^2}{4} + H^2}$$

$$A_{top} = \frac{\pi D^2}{4}$$

$$A_{bottom} = \frac{\pi d^2}{4}$$

Fig. 14 Truncated cone surface areas

Tank Heat Loss Calculation
1. Calculate surface area of tank
2. Calculate Q_v
3. Calculate Q_s
4. Calculate Q_A
5. Calculate Q_T
6. Calculate final-design heat loss

Step 2 Calculate the Q_v (heat loss through the insulated tank body)

PREPARATION

Calculating the Q_v requires the following tank information:

- Maintain temperature (T_M)
- Minimum ambient temperature (T_A)
- Insulation thickness

CALCULATION

Use the maintain and minimum ambient temperatures to arrive at the temperature differential. With the ΔT and the insulation thickness, calculate the Q_v :

- Obtain ΔT by subtracting the minimum ambient temperature (T_A) from the maintain temperature (T_M):

$$\Delta T = (T_M) - (T_A)$$
- Determine the heat loss rate (q_v) for the application. Table 9 shows the heat-loss rates (q_v) for typical temperature differentials and insulation thicknesses.
- Determine the f insulation adjustment factor. Table 10 provides insulation factors for the most commonly used tank insulations.
- Calculate the total heat loss through the tank body:

$$Q_v = A_v \times q_v \times f \text{ (insulation adjustment factor)}$$

TABLE 9 HEAT LOSS RATE (Q_v) PER SQUARE FOOT (WATTS/FT²)

ΔT °F (°C)	Insulation thickness				
	1" (25 mm)	1.5" (38 mm)	2" (51 mm)	3" (76 mm)	4" (102 mm)
50 (10)	3.4	2.3	1.7	1.2	0.9
100 (38)	7.1	4.8	3.6	2.4	1.8
150 (66)	11.0	7.5	5.6	3.7	2.8
200 (93)	15.3	10.3	7.7	5.2	3.9
250 (121)	20.0	13.5	10.2	6.8	5.1
300 (149)	24.9	16.8	12.7	8.5	6.5

TANK HEATING

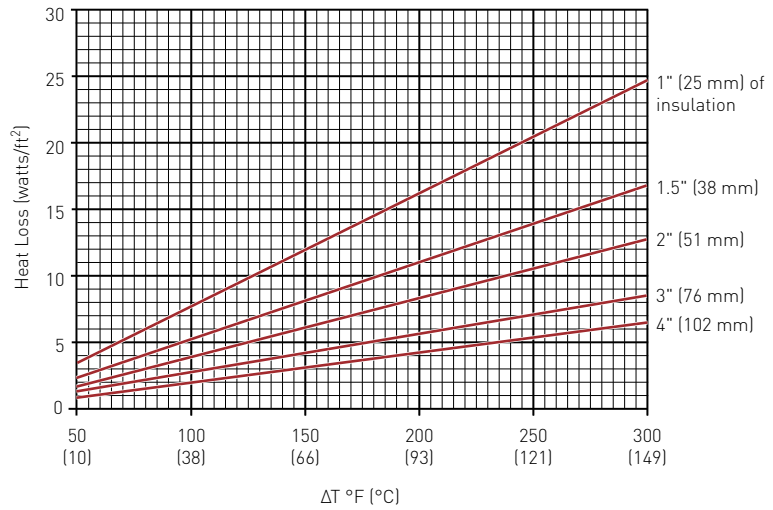

Graph 1 Heat loss rate per square foot (watts/ft²)

TABLE 10 INSULATION ADJUSTMENT FACTORS FOR TYPICAL INSULATIONS

Insulation types	Insulation adjustment factor	k factor*
Fiberglass	1.00	0.270
Cellular glass	1.46	0.395
Calcium silicate (Type 1)	1.48	0.400
Expanded perlite	1.85	0.499
Flexible elastomer	1.15	0.311
Mineral fiber blanket	1.26	0.340
Polyisocyanurate	0.67	0.180
Rigid polyurethane, preform	0.60	0.161
Rigid polyurethane, spray	0.60	0.161
Rock wool/mineral wool	1.06	0.287

* Based on a 50°F (10°C) mean temperature with units Btu/hr-°F-ft²/in

Tank Heat Loss Calculation
1. Calculate surface area of tank
2. Calculate Q_V
3. Calculate Q_S
4. Calculate Q_A
5. Calculate Q_T
6. Calculate final-design heat loss

Step 3 Calculate the Q_S (heat loss through the base support)

The following heat loss tables and accompanying graphs (Graph 2–Graph 5) provide typical base-support heat losses (Q_S) through the following types of base supports:

- Concrete slab or earth foundation
- Legs
- Concrete saddles
- Uninsulated skirt

CONCRETE SLAB OR EARTH FOUNDATION

Based on the ΔT and tank diameter, select the Q_S from Table 11 or Graph 2 below.

TABLE 11 HEAT LOSS (W) FOR A CONCRETE SLAB OR EARTH FOUNDATION

		ΔT °F (°C)					
Tank diameter		50 (10)	100 (38)	150 (66)	200 (93)	250 (121)	300 (149)
ft (m)							
5	(1.5)	137	278	451	566	711	857
10	(3)	283	573	864	1154	1452	1703
20	(6)	566	1163	1760	2325	2922	3488
30	(9)	848	1767	2616	3535	4383	5231
40	(12)	1131	2388	3518	4649	5906	7037
50	(15)	1374	2945	4320	5891	7265	8836

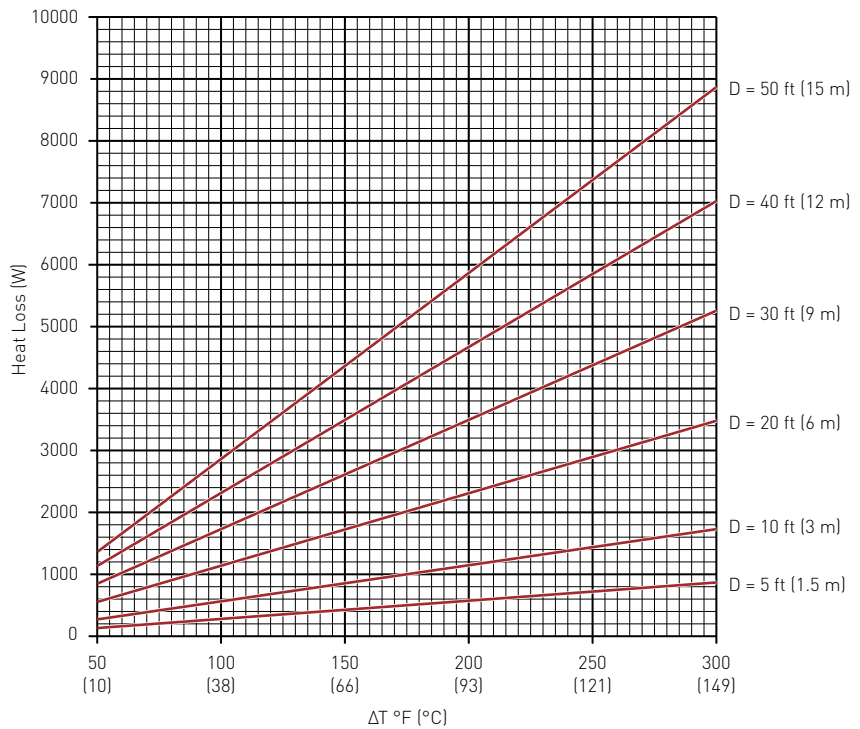

Graph 2 Heat loss (W) for a concrete slab or earth foundation

TANK HEATING

LEGS

Determine the heat loss for legs (Q_s) as follows:

- Based on the ΔT and tank diameter, select the heat loss from the Table 12 or Graph 3.
- Multiply the heat loss by the number of legs.

TABLE 12 HEAT LOSS (W) FOR A LEG SUPPORT

Tank diameter ft (m)		ΔT °F (°C)					
		50 (10)	100 (38)	150 (66)	200 (93)	250 (121)	300 (149)
5	(1.5)	26	52	77	103	129	155
10	(3) and above	85	169	351	336	420	505

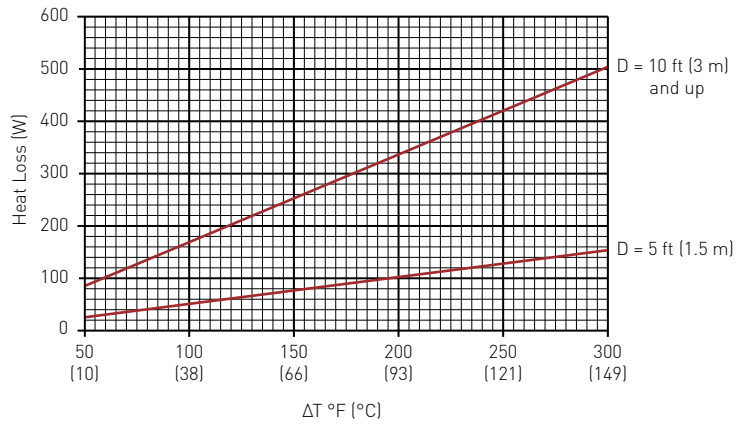

Graph 3 Heat loss (W) for leg support

CONCRETE SADDLES

Determine the heat loss for saddles (Q_s) as follows:

- Based on the ΔT and tank diameter, select the heat loss (Q_s) from Table 13 or Graph 4.
- Multiply the heat loss by the number of saddle supports.

TABLE 13 HEAT LOSS (W) FOR A CONCRETE SADDLE

Tank diameter ft (m)		ΔT °F (°C)					
		50 (10)	100 (38)	150 (66)	200 (93)	250 (121)	300 (149)
5	(1.5)	93	186	275	368	461	553
10	(3)	145	290	430	576	721	866
15	(4.6)	198	395	586	783	981	1179
20	(6)	250	500	741	991	1241	1491

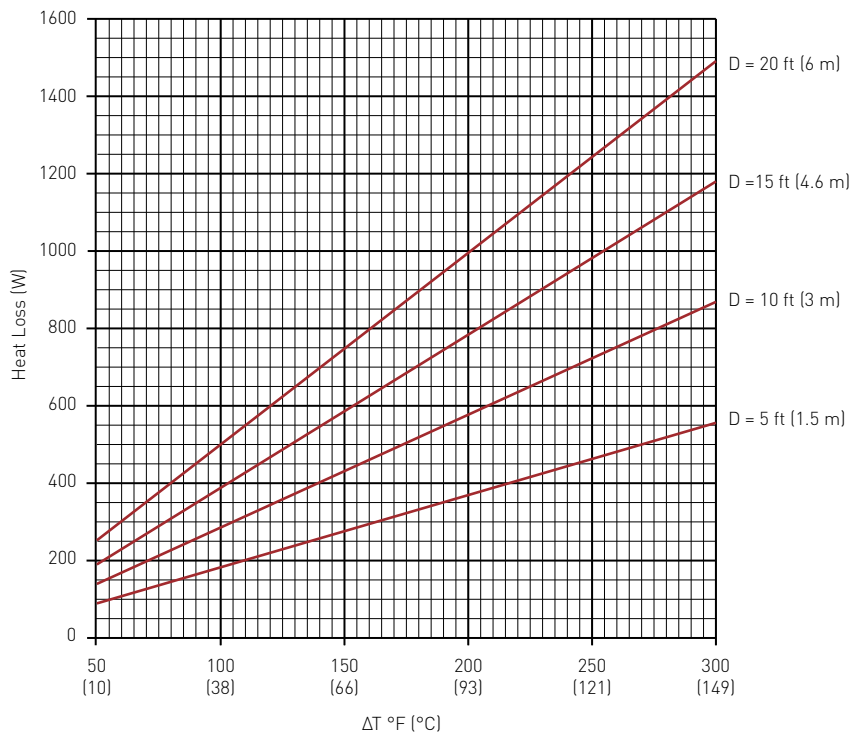

Graph 4 Heat loss (W) for a concrete saddle

TANK HEATING

UNINSULATED SKIRT

Based on the ΔT and tank diameter, select the Q_s from Table 14 or Graph 5.

TABLE 14 HEAT LOSS (W) FOR AN UNINSULATED SKIRT

Tank diameter		ΔT °F (°C)					
		50 (10)	100 (38)	150 (66)	200 (93)	250 (121)	300 (149)
5	(1.5)	402	805	1193	1595	1998	2400
10	(3)	806	1612	2389	3195	4000	4806
15	(4.6)	1209	2419	3585	4794	6003	7212
20	(6)	1613	3225	4780	6393	8006	9619

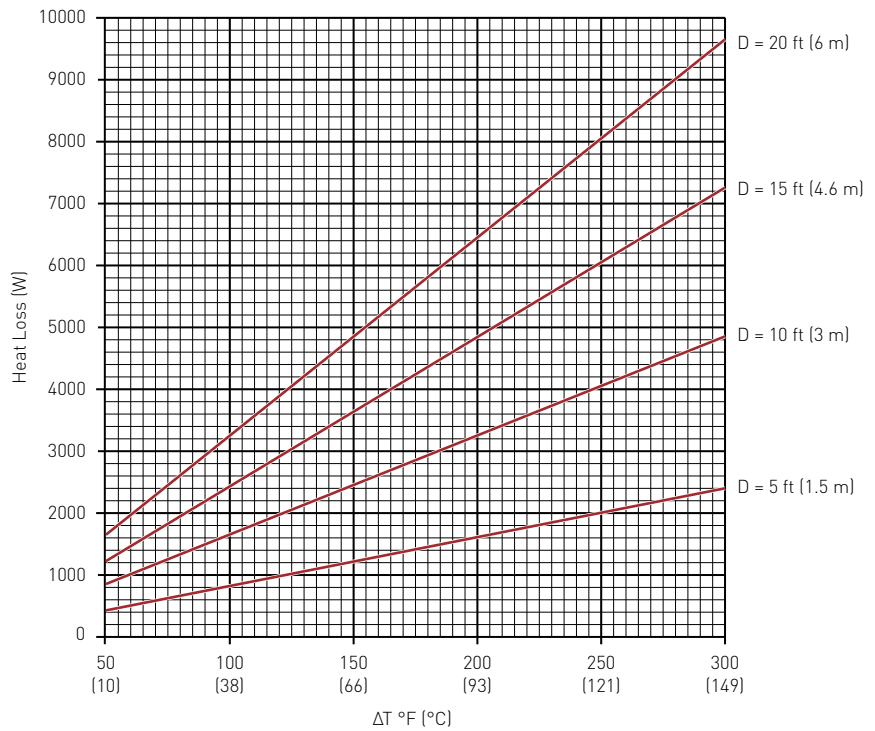

Graph 5 Heat loss (W) for an uninsulated skirt

Tank Heat Loss Calculation
1. Calculate surface area of tank
2. Calculate Q_v
3. Calculate Q_s
4. Calculate Q_A
5. Calculate Q_T
6. Calculate final-design heat loss

Step 4 Calculate the Q_A (heat loss through the accessories)

The following heat loss tables and accompanying charts provide typical accessory heat losses (Q_s) through the following types of accessories:

- Manholes
- Handholes
- Ladders
- Handrails

MANHOLES

Select the heat loss for a manhole from Table 15 or Graph 6. The heat loss is based on a 2-foot diameter cover and a 1-foot tall base. The base and cover are uninsulated.

TABLE 15 HEAT LOSS (W) FOR A MANHOLE

Heat loss (W)	ΔT °F (°C)					
	50 (10)	100 (38)	150 (66)	200 (93)	250 (121)	300 (149)
	564	1120	1680	2237	2807	3401

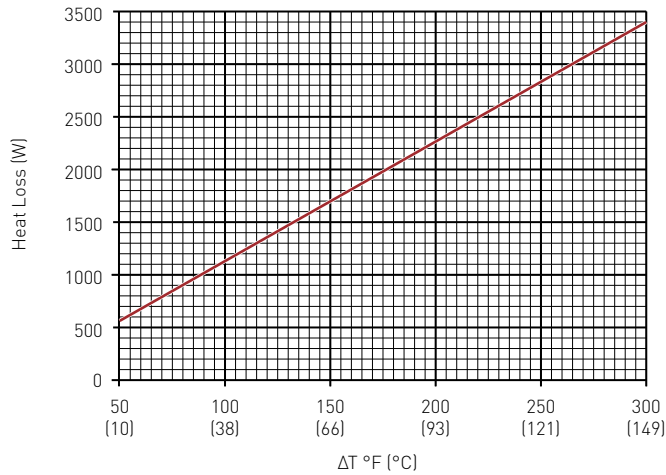

Graph 6 Heat loss (W) for a manhole

HANDHOLES

Calculate the heat loss for handholes as follows:

- Select the heat loss from Table 16 or Graph 7 based on the ΔT. Heat loss is based on a 0.5 foot diameter, uninsulated surface.
- Multiply the heat loss you select by the number of handholes.

TABLE 16 HEAT LOSS FOR A HANDHOLE

	ΔT °F (°C)					
	50 (10)	100 (38)	150 (66)	200 (93)	250 (121)	300 (149)
Heat loss (W)	90	178	265	351	437	526

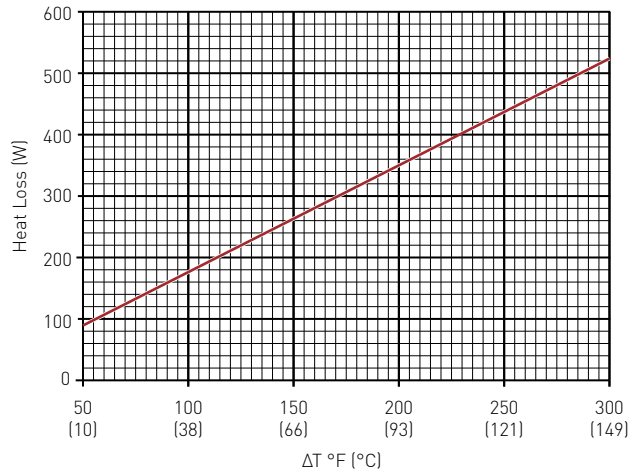

Graph 7 Heat loss (W) for a handhole

Tank Heat Loss Calculation
1. Calculate surface area of tank
2. Calculate Q_v
3. Calculate Q_s
4. Calculate Q_A
5. Calculate Q_T
6. Calculate final-design heat loss

Step 5 Calculate the QT (overall heat loss)

Add the heat-loss rates (Q_v , Q_s , and Q_A) from Steps 2, 3, and 4.

Outdoor application:

$$Q_T = Q_v + Q_s + Q_A$$

Indoor application:

$$Q_T = 0.9 \times (Q_v + Q_s + Q_A)$$

Tank Heat Loss Calculation
1. Calculate surface area of tank
2. Calculate Q_v
3. Calculate Q_s
4. Calculate Q_A
5. Calculate Q_T
6. Calculate final-design heat loss

Step 6 Calculate the final design heat loss

Pentair recommends that the final design heat loss should include a 20 percent safety factor.

$$QF \text{ (Final design heat loss)} = Q_T \times 1.20$$

Note that this same heat-loss calculation approach should be used for insulated polypropylene and fiber-reinforced plastic (FRP) tanks.



WWW.PENTAIRTHERMAL.COM

NORTH AMERICA

Tel: +1.800.545.6258
Fax: +1.800.527.5703
Tel: +1.650.216.1526
Fax: +1.650.474.7711
thermal.info@pentair.com

EUROPE, MIDDLE EAST, AFRICA

Tel: +32.16.213.511
Fax: +32.16.213.603
thermal.info@pentair.com

ASIA PACIFIC

Tel: +86.21.2412.1688
Fax: +86.21.5426.2937
cn.thermal.info@pentair.com

LATIN AMERICA

Tel: +1.713.868.4800
Fax: +1.713.868.2333
thermal.info@pentair.com

Pentair is owned by Pentair or its global affiliates. All other trademarks are the property of their respective owners. Pentair reserves the right to change specifications without prior notice.

© 2001-2016 Pentair.